

# Savio FP

WALL HUNG GAS BOILER FOR  
CENTRAL HEATING SUPPLY

**Please Read Instructions Carefully  
Save for Future Reference**

**WARNING:** If the information in this manual is not followed exactly, a fire or explosion may result causing property damage, personal injury or loss of life.

- Do not store or use gasoline or other flammable vapors and liquids in the vicinity of this or any other appliance.
- **WHAT TO DO IF YOU SMELL GAS**
  - Do not try to light any appliance.
  - Do not touch any electric switch; do not use any phone in your building.
  - Immediately call your gas supplier from a neighbor's phone. Follow the gas supplier's instructions.
  - If you can not reach your gas supplier call the fire department.
- Installation and service must be performed by a qualified installer, service agency or the gas supplier.

Manufactured by:

**BSG**

**Caldaie a Gas**  
Verona, Italy



Distributed by

 **Boyertown Furnace**

BOYERTOWN FURNACE CO.  
PO Box 100  
BOYERTOWN, PA 19512  
1-610-369-1450

SAVIO FP USER MANUAL

Dear Customer:

Thank you for buying a SAVIO FP Boiler System.

The SAVIO FP is a high efficiency, non-condensing, wall mounted gas boiler which provides central heat and domestic hot water.

We realize that it is not possible to answer all questions about the SAVIO boiler system in this manual. Reading this installation manual does not make the reader an expert in all aspects of installation and operation, and does not replace the need for a qualified, licensed heating contractor. We urge you to contact your installing contractor or distributor if you are in question about any aspect of your boiler's performance. Our main concern is that you are satisfied with your boiler and its performance. We require that your contractor complete efficiency tests using instruments.

The external controls and accessories listed in this manual (excluding those supplied inside the boiler) are intended to serve as guidelines rather than specific recommendations. We realize that other makes and models of such devices are available and can be used as successfully as those we specify. The installing contractor is the best judge of a system's specific requirements, as well as the local availability of certain makes and models of controls and accessories. The preceding does not apply, however, to the equipment that comes with every boiler, such as the overheat control and pressure relief valves. **The installation of the specific devices supplied with every boiler is absolutely necessary to the safe operation of the boiler and protection of the heating system.**

All SAVIO wall hung boilers are built in accordance with the ASME boiler and pressure vessel code, and bear the "H" stamp. The Entire range of applications for the SAVIO FP has been tested to standard CSA 4.9 and is CSA compliant.

This SAVIO boiler has a 2 year warranty on the boiler, and 10 years on the heat exchanger, a copy of which is provided with the boiler. Please be sure to return the warranty registration card as the warranty will be void without your boiler's serial numbers (located on the ratings label affixed to the boiler), date of installation and the name of your installer being on record in our files.

Thank you for purchasing our SAVIO FP boiler. If you have questions or comments, please don't hesitate to contact us immediately. Our goal is 100% customer satisfaction.

**BOYERTOWN**

# Table of Contents

Section Title	Section Number	Page Number
Warnings	-	4-5
Important Information	-	6
General Information	1	7
Technical Information	2	7-8
Appliance Description	3	9
Operation Lights	4	10
Instructions for Use	5	11-14
Warnings	5.1	11
Refilling Procedure	5.2	11
Lighting/Operation Instruction	5.3	12
Central Heating Circuit Temp.	5.4	12-13
Extinguishing Instructions	5.5	13
Domestic hot water	5.6	14
Useful Advice	6	15-17
Central Heating	6.1	15
Frost Protection	6.2	15
Periodic Maintenance	6.3	15
External Cleaning	6.4	16
Operational Faults	6.5	16-17
Warranty		18

## WARNING

Boiler is certified as an indoor appliance. Do not install boiler outdoors or locate where it will be exposed to freezing temperatures.

**WARNING:** If the information in this manual is not followed exactly, a fire or explosion may result causing property damage, personal injury or loss of life.

- Do not store or use gasoline or other flammable vapors and liquids in the vicinity of this or any other appliance.
- **WHAT TO DO IF YOU SMELL GAS**
  - Do not try to light any appliance.
  - Do not touch any electric switch; do not use any phone in your building.
  - Immediately call your gas supplier from a neighbor's phone. Follow the gas supplier's instructions.
  - If you can not reach your gas supplier call the fire department.
- Installation and service must be performed by a qualified installer, service agency or the gas supplier.

## DANGER

**Caution:** Do not store or use flammable materials, chemicals or flammable liquids, especially gasoline, in the vicinity of this heating appliance.

**Caution:** Should overheating occur or the gas supply fail to shut off, do not turn off or disconnect the electrical supply to the pump. Instead, shut off the gas supply at a location external to the appliance.

**Caution:** Do not use this boiler if any part has been under water. Immediately call a qualified service technician to inspect the boiler and to replace any part of the control system and any gas control which has been under water.

# WARNING

Any appliance that burns natural gas, propane gas, fuel oil, wood or coal is capable of producing carbon monoxide (CO). Carbon Monoxide (CO) is a gas which is odorless, colorless and tasteless but is very toxic. CO is lighter than air and thus may travel throughout the building.

**BRIEF EXPOSURE TO HIGH CONCENTRATIONS OF CO, OR PROLONGED EXPOSURE TO LESSER AMOUNTS OF CO MAY RESULT IN CARBON MONOXIDE POISONING. EXPOSURE CAN BE FATAL AND EXPOSURE TO HIGH CONCENTRATIONS MAY RESULT IN THE SUDDEN ONSET OF SYMPTOMS INCLUDING UNCONSCIOUSNESS.**

Symptoms of CO poisoning include the following:

dizziness	vision problems	shortness of breath
headache	loss of muscle control	unclear thinking
nausea	weakness	unconsciousness

The symptoms of CO poisoning are often confused with those of influenza, and the highest incidence of poisoning occurs at the onset of cold weather or during flu season.

A victim may not experience any symptoms, only one symptom, or a few symptoms.

**Suspect the presence of carbon monoxide if symptoms tend to disappear when you leave your home.**

The following signs may indicate the presence of carbon monoxide:

- Hot gasses from appliance, venting system pipes or chimney, escaping into the living space.
- Flames coming out around the appliance.
- Yellow colored flames in the appliance.
- Stale or smelly air.
- The presence of soot or carbon in or around the appliance.
- Very high unexplained humidity inside the building.

If any of the symptoms of CO occur, or if any of the signs of carbon monoxide are present, **VACATE THE PREMISES IMMEDIATELY AND CONTACT A QUALIFIED HEATING SERVICE COMPANY OR THE GAS COMPANY OR THE FIRE DEPARTMENT.**

**ONLY QUALIFIED, LICENSED SERVICE CONTRACTORS SHOULD PERFORM WORK ON YOUR SAVIO FP.**

**IMPORTANT INFORMATION**  
Please read this page carefully.

- **ALL BOILERS MUST BE INSTALLED IN ACCORDANCE WITH NATIONAL, STATE AND LOCAL PLUMBING, HEATING AND ELECTRICAL CODES AND ORDINANCES, AS WELL AS THE REGULATIONS OF THE SERVING ELECTRICAL, WATER AND GAS UTILITIES.**
- **All systems should be designed by competent contractors, and only persons knowledgeable in the layout and installation of heating systems should attempt the installation of any boiler. It is the responsibility of the installing contractor to see that all controls are correctly installed and operating properly when the installation is completed.**
- **This boiler is intended for use, only with propane or natural gas. All flammable liquids (especially gasoline), chemicals, rags, paper, wood scraps, debris, etc., should be kept away from the boiler at all times. Keep the boiler area clean and free of all fire hazards.**
- **Please read the literature and warranties supplied by the manufacturers of the various accessory equipment. This equipment is warranted by the respective manufacturers, not by BOYERTOWN. Each piece of equipment must be installed and used according to the recommendations of the manufacturer.**

**Codes and Regulations:**

Installation of the boiler and related equipment must conform to national, state and local regulating agencies and codes applicable to the installation of the equipment. In the absence of local requirements, the following codes apply:

- |   |
|---|
| A. ANSI/NFPA - #70 National Electric Code     |
| B. ANSI/NFPA - #211 Chimneys and Vents        |
| C. ANSI/NFPA - #Z223.1 National Fuel Gas Code |
| C. ANSI/NFPA - Domestic Gas Conversion Burner |
| D. CAN/CGA - B149 Installation Codes          |
| E. ANSI/ASME - CSD-1                          |

The above codes are available from:

National Fire Protection Association (NFPA)  
Battery March Park  
Quincy, Massachusetts, 02269  
<http://www.nfpa.org>

CSA International  
8501 E. Pleasant Valley Road  
Cleveland, OH 44134-5575  
<http://www.csa-international.org>

# 1. General Information

The SAVIO FP is a high efficiency, non-condensing, wall mounted gas boiler which provides central heat. The boiler features a gas valve which modulates the energy input from 49,476BTU/h to 122,837 BTU/h. The boiler is shipped fully assembled. All units are pressure and combustion tested at the factory prior to shipping.

## Key Features:

- Wall mountable - saving valuable floor space.
- Several flue options available
- Electronic spark ignition
- Safety flow switch - positioned on the main circuit, which monitors the flow and protects the main heat exchanger from thermal shock should there be a lack of water in the system.
- Frost protection - contains an integral frost protection system to prevent frost damage which can occur in areas susceptible to very cold weather conditions.
- Boiler operation recognition system - should the boiler not be used for longer than 24 hours, it then performs a controlled system test to ensuring the motorized components within the boiler do not become inoperable due to lack of use.
- Gas valve modulation - the gas input modulates based off central heating temperature to within  $\pm 2$  °F
- Diagnostic information system equipped with three LED diagnostic lights for quick error assessment.

# 2. Technical Information (M130.30CM)

GENERAL		
Height	in	27.7
Width	in	15.7
Depth	in	12.8
Weight	lb	78.7

ELECTRICAL		
Voltage	V	120
Frequency	Hz	60
Current	A	1.6
Power consumption	W	180

INJECTORS	No.	Size
Natural	14	130
Propane	14	89

CENTRAL HEATING		
Maximum working temp.	°F	185
Temp. Regulation range*	°F	100-176
Maximum pressure	psi	30.0
Minimum pressure	psi	4.35
Max head loss (at 4.4 GPM)	ft	9.9
*At the minimum useful output		

## 2. Technical Information Cont.

ENERGY CAPACITY		
Nominal heat input (0/2000ft)	MBH	122.8
Nominal heat input (2000/4500ft)	MBH	116.7
Minimum heat input	MBH	49.5
Maximum useful output (0/2000ft)	MBH	100.7
Maximum useful output (2000/4500ft)	MBH	95.9
Minimum useful output	MBH	37.0

GAS SUPPLY PRESSURE				
Gas		Normal	Min	Max
Natural	inwc	7.0	3.5	10.5
Propane	inwc	11.0	8.0	13.0

GAS PRESSURE AT BURNER				
Gas		Min	Max	Ignition
Natural	inwc	0.8	5.3	2.4
Propane	inwc	1.4	9.0	5.2

FLUE DESIGN		
Minimum Venturi pressure	inwc	0.66
Flue pipe diameter		
Coaxial	in	2.25/4 3.25/5
Twin split pipes	in	3.25/3.25
Nominal heat flow rate (0/2000ft)	MBH	122.8
Nominal heat flow rate (2000/4500ft)	MBH	116.7
Min Exhaust temperature	°F	262
Max Exhaust temperature	°F	324

GAS FLOW RATE			
Gas		Min	Max
Natural	ft <sup>3</sup> /h	48.7	121.1
Propane	lb/h	2.2	5.6

CLEARANCE TO COMBUSTIBLES		
Front	in	18
Back	in	0
Top	in	8
Sides	in	2
Bottom	in	8
Flue pipe enclosed	in	2
Flue pipe free air	in	0
Hot water pipes	in	1"

FLUE GAS FIGURES		
Gas	Min	Max
CO <sub>2</sub>	2.5%	7.2%
O <sub>2</sub>	16.5%	8.1%

DOMESTIC HOT WATER		
Maximum temperature	°F	131
Minimum temperature	°F	95
Maximum pressure	psi	145
Minimum pressure	psi	4.35
D.h.w. ΔT 25K	gpm	4.5
D.h.w. ΔT 30 K	gpm	3.7
D.h.w. ΔT 35 K	gpm	3.2
D.h.w. ΔT 40 K	gpm	2.8

# 3. Appliance Description

## 3.1 Overview:

- 1 Case front panel
- 2 Control panel
- 3 Control panel cover

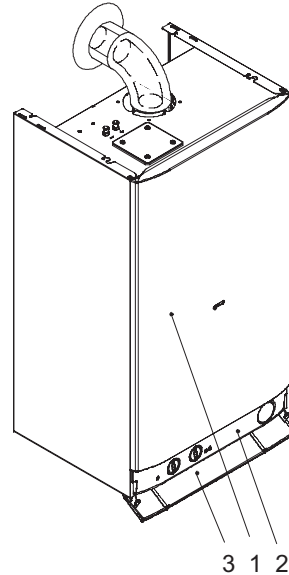

Figure 3.1

## 3.2 Control Panel:

- 4 Central heating circuit temperature and pressure gauge
- 5 Lock-out signal lamp
- 6 Boiler reset button
- 7 Function selector knob and radiator temperature control
- 8 Domestic hot water, temperature control knob
- 9 Appliance operation lights

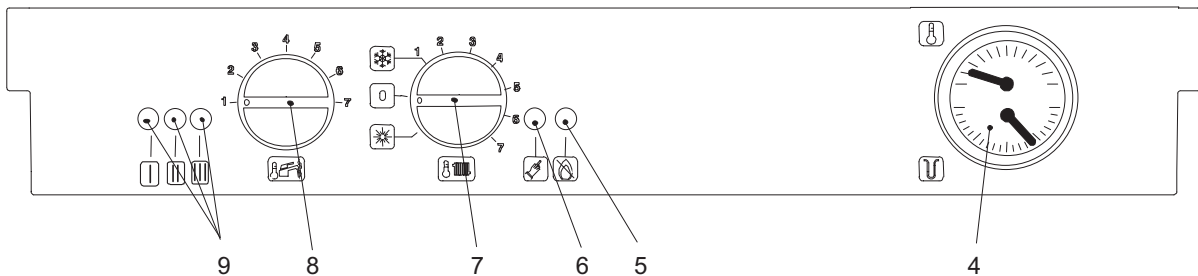

Figure 3.2

## 3.3 Piping Connections:

- A Gas inlet pipe
- B Main circuit drain cock
- C C.h. supply copper pipe
- D C.h. return copper pipe
- E C.h. PRV discharge copper pipe
- F D.h.w. hot water outlet
- G D.h.w. cold water inlet

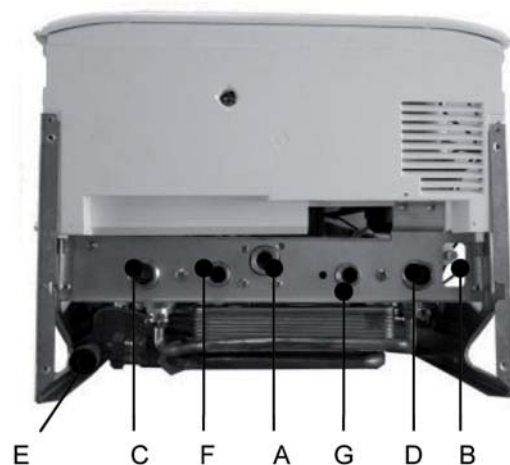



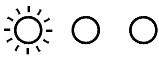













Figure 3.3

## 4. Operation Lights

Three lights (8 in Fig. 3.2) give detailed indication regarding the operation of the boiler. The following table gives the relationship between each of the possible light combinations and their meaning.

  	
	A short pulse every 4 seconds: stand-by condition Function selector in  position. Anti-freeze system active 1 second pulse every 2 seconds: normally operating boiler. Function selector in on position
	Central heating operation
	Frost protect operation
	Faulty central heating temperature probe NTC
	Faulty primary circuit (no water or absence of flow)
	Lack of burner ignition (no ignition signal from the full sequence ignition device)
	Ignition gas pressure adjustment
	Minimum gas pressure adjustment

			
Lamp OFF	Lamp ON	Flashing lamp, alone or simultaneously with another lamp.	Flashing lamp, alternate with another lamp

## 5. Instructions For Use

### 5.1 Warnings:

- In order to guarantee safety and correct operation, it is essential that all the tests are carried out by a competent and responsible licensed service person before lighting up the boiler.
- The tests are described in the installation, operation and service instructions manual in Section 15 Commissioning.
- Ensure that the Central Heating circuit is regularly filled with water checking that the pressure indicated on the temperature and pressure gauge (4 on figure 3.2) is not lower than 1 bar (14.5 psi) as shown on figure 5.1.
- If the pressure reading on the pressure gauge is below 1 bar (14.5 psi), then the system will require filling. An automatic filling valve is normally provided by the installer for this purpose.
- **If you are in any doubt regarding this procedure you are advised to contact your Installer or an Approved Service Person.**
- This appliance is provided with a built in anti-freeze system that operates the boiler when the temperature is below 41 °F
- Therefore, when the boiler is not lit or used in cold weather, with consequent risk of freezing **do not switch off the boiler at the circuit breaker or close the gas inlet cock.**
- When you expect not to use the boiler for a long period follow the instructions given in section 5.6 on page 14.

### 5.2 Refilling procedure:

- Isolate the boiler from the electrical supply at the circuit breaker.
- The boiler should have been installed with an automatic fill valve, external to the unit. Open the cold water supply to the automatic fill valve.
- The pressure should be 1 – 1,5 bar (14.5 – 22 psi).
- The automatic fill valve should maintain this pressure, but not exceed it.

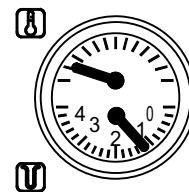

Figure 5.1

Air introduced into the boiler during this filling process will vent through the automatic air purger fitted to the boiler. You may also find it necessary to vent air from your heating circuit using the installed vents, however be aware that excessive venting will cause the pressure in the system to drop. Always ensure that the pressure gauge is set at the required pressure.

## 5. Instructions For Use Cont.

### 5.3 Lighting/Operating Instructions:

**Warnings:** Do not attempt to start the boiler unless all cleanout doors are secured and sealed. Do not attempt to light the burner by hand.

- 1 Check that the cocks connected to the gas inlet pipe and to the supply cold water inlet pipe (see section 3.3 for pipes) are open.
- 2 Turn on the electricity supply to the boiler, switching on the circuit breaker. The appliance operation light A (figure 5.2) will flash every 4 seconds (stand-by condition).
- 3 If the boiler is to be used for c.h. position the function selector C as in figure 5.2. The appliance operation light A will flash every 2 seconds (operating boiler).
- 4 If the appliance will not operate, follow the extinguishing instructions on page 13 and call your service technician or gas supplier.

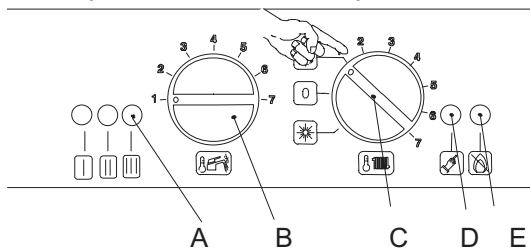

Figure 5.2

### 5.4 Central Heating Circuit Temperature:

- 1 The output temperature of c.h. water is adjustable from a minimum of about 100 °F to a maximum of about 176 °F (Figure 5.3), by turning the knob B
- 2 Adjustment of the boiler temperature alters the gas flow at the burner according to the thermal demand in the system. So it is usual to see the burner lit at the minimum level for more or less long periods.
- 3 Adjustment of central heating output on the boiler is automatic. The greatest output is factory pre-set, however, it can be reduced according to actual system requirements. These adjustments must be carried out by a qualified person; therefore we advise you to contact your installer or Service Agent.

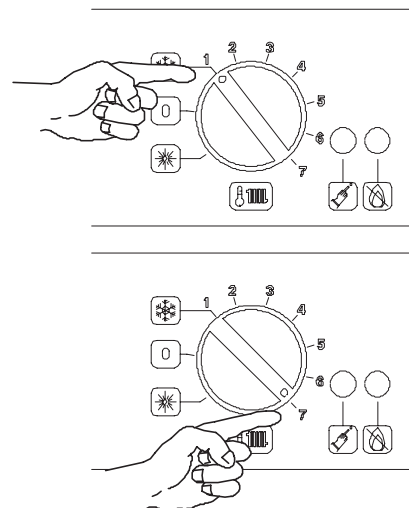

Figure 5.3

## 5. Instructions For Use Cont.

### Adjustment:

- In order to achieve optimal settings for economy and comfort, we recommend adjusting the operating temperature of the central heating water according to the outside temperature, positioning the knob as in figure 5.4
- Your installer may have installed additional energy saving equipment and will be able to recommend the most suitable adjustment for your system.
- The temperature and pressure gauge (Fig. 5.1 on page 11) will allow you to check that the set temperature is obtained.

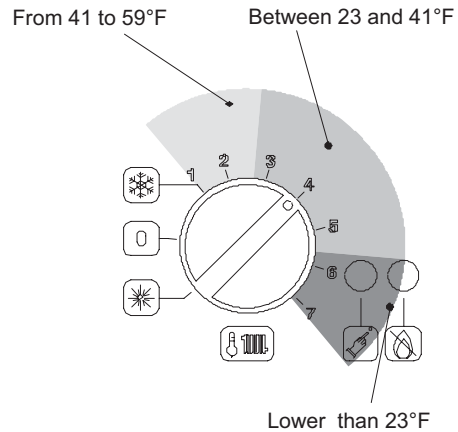

Figure 5.4

### 5.5 Extinguishing Instructions:

- To turn the boiler off set the function selector C to the position shown in the Figure 5.5.
- The appliance operation light A (figure 5.2) will flash every 4 seconds (stand-by mode).
- Turn off electric power to the appliance at the circuit panel of boiler serviceman's switch.

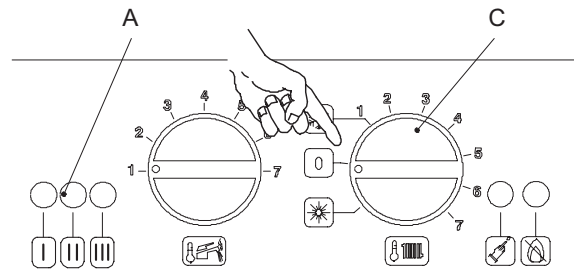

Figure 5.5

### When you expect not to use the boiler for a long period:

- Switch off the electricity supply to the boiler, by means of the circuit breaker;
- Shut off the gas supply cock connected to the gas inlet pipe and the cock connected to the supply cold water inlet pipe (see section 3.3 for pipes)
- Empty the water circuit, if necessary, as shown in the installation, operation and service instructions manual in the maintenance section.

## 5. Instructions For Use Cont.

### 5.6 Domestic hot water temperature:

The temperature of the domestic hot water coming out from the boiler can be regulated from a minimum of approximately 95° F to a maximum of approximately 131° F by turning the control shown in fig. 5.6

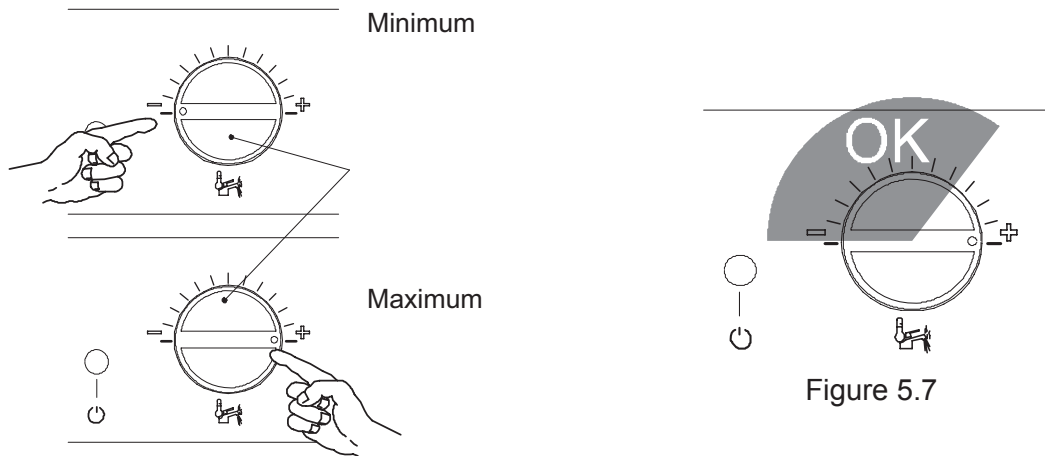

Figure 5.6

Figure 5.7

Adjustment of the d.h.w. temperature is completely separate from that of the c.h. circuit.

The adjustment system integrated within the boiler automatically controls the flow of gas to the burner in order to keep the temperature of d.h.w. delivered constant, between the limits of maximum and minimum output.

Where the demand is at a low level or with the temperature set to the minimum, it is normal to see a cycle of lighting and extinguishing of the burner when running.

Regulate the domestic hot water temperature to a value suitable for your requirements.

Reduce the need to mix the hot water with cold water.

In this way, you will appreciate the characteristics of automatic regulation.

If the water is particularly hard, we recommend regulating the boiler at a temperature lower than 120° F fig.

In these cases, we nevertheless recommend the installation of a water-softener on the domestic hot water system.

If the maximum flow rate of the domestic hot water is too high for a sufficient temperature to be reached, it is advisable to have a suitable flow rate limiter installed by an Authorised Assistance Technician.

## 6. Useful Advice

### 6.1 Central Heating:

- For reasonably economical service install a room thermostat.
- Never shut off the radiator in the area where the room thermostat is installed.
- If a radiator (or a convector) does not heat up, check that no air is present in it and that its valve is open.
- If the ambient temperature is too high, do not alter the radiator valves. Reduce the central heating temperature instead by means of the room thermostat and the knob (C in Fig. 6.1).

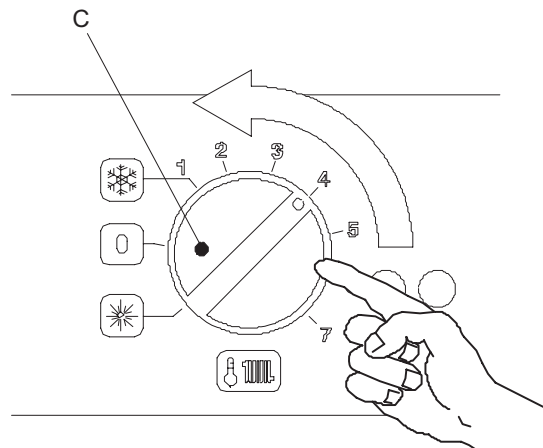

Figure 6.1

### 6.2 Frost Protection:

- The built in antifreeze system and any additional system protect the boiler from possible damages due to the icing.
- This system doesn't guarantee the protection of the whole central heating system.
- In the case that the external temperature may be lower than 32°F it is suggested to leave the system running setting the room thermostat at a low temperature.
- When the boiler is completely switched off for a long period, it is recommended to empty completely central heating circuit.

### 6.3 Periodic Maintenance:

- For efficient and continuous operation of the boiler, it is advisable to arrange maintenance and cleaning by an Authorised Service Person, at least once a year.
- During the service, the most important components of the boiler will be inspected and cleaned. This service can be part of a maintenance contract.

In particular, you are advised to have the following checks carried out:

- primary heat exchanger;
- burner;
- exhaust fume duct and flue;
- pressurization of the expansion vessel;
- filling up of the central heating circuit;
- bleeding of air from the central heating system;
- general check of the appliance's operation.

## 6. Useful Advice Cont.

### 6.4 External Cleaning:

- Before performing any cleaning, disconnect the appliance from the electrical mains, using the dedicated circuit breaker or serviceman's switch located adjacent to the appliance.
- To clean the external panels, use a cloth soaked in soapy water. Do not use solvents, abrasive powders or sponges.
- Do not carry out cleaning of the appliance and/or its parts with readily flammable substances (for example petrol, alcohols, naphtha, etc.).

### 6.5 Operational Faults:

#### If the lock-out signal lamp comes on:

- This indicates that the safety lock-out 1 (Fig. 6.2) has stopped the boiler
- To re-start the boiler, it is necessary to turn the function selector B in the position  and then press the boiler reset button 2 (Fig. 6.2).
- For the first light up and following maintenance procedures for the gas supply, it may be necessary to repeat the resetting operation several times so as to remove the air present in the pipework.

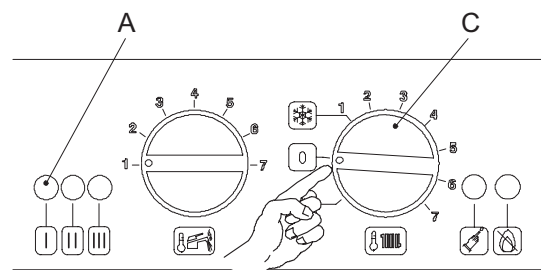

Figure 6.2

#### If noises due to air bubbles are heard during operation:

- You should check that the pressure on the temperature and pressure gauge (Fig. 5.1 on page 11) is not below the correct setting.
- If required, fill up the system correctly, as described in the section 5.2 of this manual.
- Bleed any air present in the radiators, if necessary.

#### If the pressure on the temperature and pressure gauge (Figure 5.1 on page 9) has gone down:

- It is necessary to fill up the appliance with water again, so as to raise the pressure to an adequate level as described in the section 5.2 of this manual.
- If filling up with water has to be done very frequent, have the system checked for leaks.

## 6. Useful Advice Cont.

### **If water comes out of the pressure relief valve pipe 3 in Fig. 6.3:**

- Check on the temperature and pressure gauge (figure 5.1 on page 11) that the pressure in the central heating circuit is not close to 3 bars (43.5 psi). In this case, temperature rise in the circuit can cause the pressure relief valve to open.
- So that this does not happen and to decrease the pressure to a normal value, it is advisable to vent some of the water in the appliance through the bleed valves present in the heating system.



Figure 6.3

### **If water should occasionally leak from the boiler:**

- Close the cocks connected to the inlet gas pipe and to the supply cold water inlet pipe under the boiler and call an Authorised Service Person.

**In case of problems other than those mentioned here, switch off the boiler, as described in Section 5.5 on page 13 and call a competent and responsible service person.**

## Warranty For SAVIO Residential Wall Hung Gas Boilers

FIRST 2 YEARS-WARRANTY FOR SAVIO SERIES RESIDENTIAL HOT WATER BOILERS: BOYERTOWN warrants that its wall hung boiler and casing are free from defects in material and workmanship for 2 years from the date of installation. If any part on the boiler is found to be defective within this period, BOYERTOWN will replace the part free of charge.

FIRST 10 YEARS-WARRANTY FOR SAVIO SERIES RESIDENTIAL HOT WATER BOILERS: SAVIO warrants that the copper tube heat exchanger of the SAVIO boilers are free from defects in material and workmanship for 5 years from the date of installation. If the copper tube heat exchanger is found to be defective within the first 5 years after installation, BOYERTOWN and SAVIO will replace the copper tube heat exchanger.

These warranties are subject to the condition that a heating contractor whose principal occupation is the sale and installation of heating equipment must have installed the boiler. PARTS, WHICH ARE COVERED, consists of all materials supplied by SAVIO, identified by BOYERTOWN's part numbers in its literature. Other parts supplied by the installer carry their own warranty and each manufacturer has responsibility for its own products.

NOTE: ANY PART, WHICH IS REPLACED UNDER WARRANTY, CARRIES ONLY THE UNEXPIRED PORTION OF THE ORIGINAL WARRANTY.

#### OWNER RESPONSIBILITIES:

1. Provide for proper installation, which includes pressure relief and pressure reducing valves and high limit safety controls on closed systems.
2. Provide qualified periodic service to prolong proper operation and service.
3. Insure that boiler is installed in accordance with all codes and ordinances.
4. This warranty does not apply to boilers, which are subject to misuse, abuse, neglect, alteration, accident, excessive temperature, excessive pressure, or corrosive water or atmosphere.
5. Owner will be responsible for return of faulty components to BOYERTOWN, PA, freight pre-paid.

- BOYERTOWN and SAVIO will not be responsible for:
1. Components that are part of the heating system, but were not manufactured by SAVIO or BOYERTOWN as part of the boiler.
  2. The workmanship of the installers of SAVIO boilers. Furthermore, this warranty does not assume any liability for unsatisfactory performance caused by improper installation.
  3. Any costs for labor to remove or replace the faulty component.
  4. Improper boiler application or adjustments, control settings, care or maintenance.
  5. Any damage associated with corrosion or leakage due to the use of "non-barrier", plastic pipe in the heating system.

\*IMPLIED WARRANTIES OF FITNESS FOR A PARTICULAR PURPOSE AND MERCHANTABILITY SHALL BE LIMITED TO THE DURATION OF THE EXPRESSED WARRANTY. SAVIO AND BOYERTOWN EXPRESSLY DISCLAIM AND EXCLUDE ANY LIABILITY FOR CONSEQUENTIAL OR INCIDENTAL DAMAGES FOR BREACH OF ANY EXPRESSED OR IMPLIED WARRANTY.

THIS WARRANTY GIVES YOU SPECIFIC LEGAL RIGHTS, AND YOU MAY HAVE OTHER RIGHTS THAT VARY FROM STATE TO STATE.

For prompt warranty service, notify the installer, who, in turn, will notify the distributor from whom the boiler was purchased. If this does not result in corrective action, contact SAVIO through BOYERTOWN Hydronic Technologies (Address Below) with details in support of the warranty claim. All claims must be processed through proper trade channels. Contact with SAVIO directly is not recommended for rapid claim settlement.

BOYERTOWN Furnace Co.  
PO Box 100  
Boyertown, PA 19512  
1-610-369-1450  
[www.boyertownfurnace.com](http://www.boyertownfurnace.com)

---

### SAVIO BOILER WARRANTY REGISTRATION

*IMPORTANT., Registration required. To gain complete warranty Protection, fill in and mail this card, within 1 year of installation to the address listed below*

NAME: \_\_\_\_\_ ADDRESS: \_\_\_\_\_  
CITY: \_\_\_\_\_ STATE: \_\_\_\_\_ ZIP: \_\_\_\_\_  
BOILER SERIAL NO.: \_\_\_\_\_ DATE OF INSTALL: \_\_\_\_\_  
NAME OF INSTALL CO.: \_\_\_\_\_ ADDRESS: \_\_\_\_\_  
CITY: \_\_\_\_\_ STATE: \_\_\_\_\_ ZIP: \_\_\_\_\_

RETURN TO: BOYERTOWN FURNACE Co. PO Box 100 BOYERTOWN PA 19512 1-610-369-1450





17962.1512.0 2908 (20A4)USA

